





Nylon-Kippdübel DUOTEC

Typ	Art.-Nr.	GTIN (EAN-Code)	Verkaufseinheit [Stück]	Umkarton [Stück]	Preis 100 St. €	PG	TZ	Bohrernenn- durchmesser [mm]	Min. Plattendicke [mm]	Max. Plattendicke [mm]	Schraubendurchmesser [mm]
 fischer DUOTEC											
fischer DUOTEC 10	537258	4048962254075	50	400	90,40	107	A	10	12	55	4,5 - 5,0
fischer DUOTEC 10 S PH	539025 ¹⁾	4048962267426	25	300	95,65	107	N	10	12	55	5,0
fischer DUOTEC 12	542796	4048962299830	10	160	177,20	107	A	12	12	55	5,0 - 6,0 / M6
fischer DUOTEC 12 S PH M	542797 ²⁾ ₁₎	4048962299847	10	240	187,50	107	N	12	12	55	M6

1) fischer DUOTEC S PH - mit Spanplattenschraube Panhead

2) fischer DUOTEC S PH - mit Maschinenschraube Panhead

Hohlraum-Metalldübel HM



Typ	Art.-Nr.	GTIN (EAN-Code)	Verkaufseinheit [Stück]	Umkarton [Stück]	Preis 100 St. €	PG	TZ	Bohrernenn- durchmesser [mm]	Plattendicke min / max [mm]	Max. Dicke des Anbauteils bei min. Plattendicke [mm]	Max. Dicke des Anbauteils bei max. Plattendicke [mm]	Schraubenab- messung [mm]
 Hohlraum-Metalldübel HM mit Schraube												
HM 4 x 32 S	519769	4048962164824	50	500	60,90	160	F	8	3 / 13	25	15	M 4 x 40
HM 4 x 45 S	519770	4048962164831	50	250	65,35	160	F	8	16 / 23	21	12	M 4 x 52
HM 4 x 60 S	519771	4048962164848	50	250	69,30	160	F	8	31 / 40	21	12	M 4 x 65
HM 5 x 37 S	519772	4048962164855	50	250	69,35	160	F	10	6 / 15	17	8	M 5 x 45
HM 5 x 52 S	519774	4048962164879	50	250	74,15	160	F	10	7 / 21	24	10	M 5 x 58
HM 5 x 65 S	519775	4048962164886	50	250	90,05	160	F	10	20 / 34	26	12	M 5 x 71
HM 6 x 37 S	519777	4048962164893	50	250	75,80	160	F	12	6 / 15	21	12	M 6 x 45
HM 6 x 52 S	519778	4048962164909	50	250	80,20	160	F	12	7 / 21	28	14	M 6 x 58
HM 6 x 65 S	519782	4048962164947	50	250	95,90	160	F	12	17 / 34	30	13	M 6 x 71
HM 6 x 80 S	519779	4048962164916	50	250	108,80	160	F	12	32 / 50	34	16	M 6 x 88
 Hohlraum-Metalldübel HM mit Sechskantschraube												
HM 8 x 54 SS	519783 ¹⁾	4048962164954	50	250	149,35	160	F	12	7 / 21	30	16	M 8 x 60
 Hohlraum-Metalldübel HM mit Haken												
HM 4 x 32 H	519780	4048962164923	50	250	75,90	160	F	8	3 / 13	-	-	-
HM 5 x 65 H	519781	4048962164930	50	250	112,80	160	F	10	20 / 34	-	-	-

1) mit Sechskantschraube, Montage nur mit Montagezange HM Z1



Montage Set Hohlraumbefestigung

Typ	Art.-Nr.	GTIN (EAN-Code)	Verkaufs- einheit [Stück]	Umkarton [Stück]	Preis 1 Stück €	PG	TZ	Inhalt
 <p>Montage Set Hohlraumbefestigung</p>								
Montage Set Hohlraumbefestigung	531389	4048962208993	1	6	30,90	90	Z	20 x Hohlraum-Metalldübel HM 5 x 52, 20 x Schraube M 5 x 60, 10 x Hohlraum-Metalldübel HM 5 x 65, 10 x Schraube M 5 x 73, 1 x Montagezange HM Z3

Hohlraum-Montagezange

Typ	Art.-Nr.	GTIN (EAN-Code)	Verkaufs- einheit [Stück]	Umkarton [Stück]	Preis 1 Stück €	PG	TZ
 <p>HM-Z 1 - die Profizange</p>							
HM Z 1	062320	4006209623206	1	30	62,85	160	T
 <p>Montagezange HM Z 2</p>							
HM Z 2	062321	4006209623213	1	6	24,90	300	T
 <p>Montagezange HM Z 3</p>							
HM Z 3	539723	4048962271034	1	6	19,20	300	T

Kippdübel

Typ	Art.-Nr.	GTIN (EAN-Code)	Verkaufs- einheit [Stück]	Umkarton [Stück]	Preis 100 St. €	PG	TZ	Bohrerennendurch- messer [mm]	Dübel- länge [mm]	Max. Plattendicke [mm]	Gewinde [mm]
 <p>Federklappdübel KD 3 + 4</p>											
KD 3	080181	4006209801819	50	50	95,95	155	F	12	95	65	M 3 x 90
KD 4	080183	4006209801833	25	25	128,50	155	F	14	105	69	M 4 x 100
 <p>Federklappdübel KD</p>											
KD 3 B	080192	4006209801925	10	250	102,25	155	F	12	95	65	M 3 x 90
KD 4 B	080193	4006209801932	10	200	139,20	155	F	14	105	69	M 4 x 100



Hohlraum-Befestigungen

Befestigungs-systeme

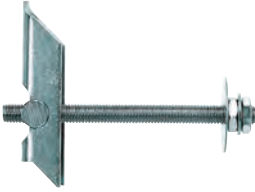
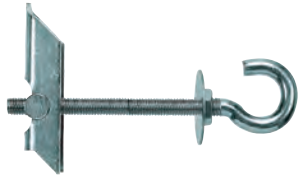
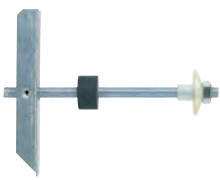
Kippdübel

Typ	Art.-Nr.	GTIN (EAN-Code)	Verkaufseinheit [Stück]	Umkarton [Stück]	Preis 100 St. €	PG	TZ	Bohrerenddurchmesser [mm]	Dübellänge [mm]	Max. Plattendicke [mm]	Gewinde [mm]
											
											
											
											
KDH 3	080182	4006209801826	25	25	120,45	155	F	12	105	51	M 3 x 80
KDH 4	080184	4006209801840	25	25	150,35	155	F	14	95	35	M 4 x 70
KD 5	080187	4006209801871	25	25	172,05	155	F	16	100	63	M 5 x 100
KD 6	080185	4006209801857	25	25	225,35	155	F	16	100	63	M 6 x 100
KD 8	080178	4006209801789	20	20	325,30	155	F	20	100	55	M 8 x 100
KDH 5	080188	4006209801888	20	20	230,35	155	F	16	130	60	M 5 x 90
KDH 6	080186	4006209801864	20	20	271,50	155	F	16	130	60	M 6 x 100
KDH 8	080179	4006209801796	20	20	349,30	155	F	20	130	55	M 8 x 100
KM 10	050326	4006209503263	25	25	1.807,80	155	N	30	180	90	M 10 x 180

Plattendübel PD

Typ	Art.-Nr.	GTIN (EAN-Code)	Verkaufseinheit [Stück]	Umkarton [Stück]	Preis 100 St. €	PG	TZ	Bohrerenddurchmesser [mm]	Min. Bohrlochtiefe [mm]	Plattendicke [mm]	Spanplattenschrauben [mm]
											
											
PD 8	024771	4006209247716	100	5000	19,40	190	A	8	31	-	4
PD 10	015935	4006209159354	100	2500	25,10	190	A	10	30	-	5
PD 12	015937	4006209159378	50	2500	30,80	190	A	12	29	-	6
PD 8 S	024772	4006209247723	50	2500	42,50	190	N	8	31	-	4 x 40
PD 10 S	015936	4006209159361	50	1250	54,90	190	N	10	30	-	5 x 40
PD 12 S	015938	4006209159385	25	1250	66,95	190	N	12	29	-	6 x 50



1) PD-S mit Spanplattenschraube

DUOBLADE

Typ	Art.-Nr.	GTIN (EAN-Code)	Verkaufseinheit [Stück]	Umkarton [Stück]	Preis 100 St. €	PG	TZ	Dübellänge [mm]	Schraubenabmessung [mm]	Dübellänge ohne Bohrspitze [mm]	Min. Bohrlochtiefe bei Vorsteckmontage [mm]	Verankerungstiefe [mm]
												
DUOBLADE	545675	4048962323702	50	50	32,15	165	A	44	4 - 5	29	50	9,5 - 25
DUOBLADE S	545676	4048962323719	25	25	48,90	165	N	44	4,5 x 40	29	50	9,5 - 25



1) DUOBLADE S mit Spanplattenschraube

Gipskartondübel GK

Typ	Art.-Nr.	GTIN (EAN-Code)	Verkaufs- einheit [Stück]	Umkarton [Stück]	Preis 100 St. €	PG	TZ	Dübellänge [mm]	Min. Dicke bis zur ersten Tragschicht [mm]	Max. Dicke des Anbauteils [mm]	Schraubenabmessung [mm]
 <p style="text-align: center;">Gipskartondübel GK</p>											
GK	052389	¹⁾ ₂₎ 4006209523896	100	2500	20,40	165	A	22	25	-	4,0 - 5,0 x Ls
 <p style="text-align: center;">Gipskartondübel GKS</p>											
GK S	052390	³⁾ ₂₎ 4006209523902	50	1250	45,10	165	N	22	25	13	4,5 x 35
 <p style="text-align: center;">Setz- und Eindrehwerkzeug GKW</p>											
GKW	052393	4006209523933	10	10	480,35	190	Z	-	-	-	-

1) Mindestschraubenlänge = Dübellänge 22 mm + Befestigungsdicke des anzuschließenden Bauteils.
 2) Inklusive einem Setz- und Eindrehwerkzeug GKW.
 3) Wird komplett mit Spanplattenschrauben geliefert.

Gipskartondübel Metall GKM

Typ	Art.-Nr.	GTIN (EAN-Code)	Verkaufs- einheit [Stück]	Umkarton [Stück]	Preis 100 St. €	PG	TZ	Dübellänge [mm]	Min. Dicke bis zur ersten Tragschicht [mm]	Max. Dicke des Anbauteils [mm]	Schraubenabmessung [mm]
 <p style="text-align: center;">Gipskartondübel Metall GKM</p>											
GKM	024556	4006209245569	100	100	32,15	165	F	31	35	-	4,0 - 5,0 x Ls
 <p style="text-align: center;">Gipskartondübel Metall GKM 12 + Spanplattenschraube</p>											
GKM 12	040432	¹⁾ 4006209404324	100	100	48,90	165	F	31	35	12	4,5 x 35
GKM 27	040434	²⁾ 4006209404348	100	100	52,55	165	F	31	35	27	4,5 x 50

1) Wird komplett mit Spanplattenschraube Pilzkopf geliefert.
 2) Wird komplett mit Spanplattenschraube Senkkopf geliefert.

Hohlraum-Befestigungen

Befestigungs-systeme